

JBR-3323 Trimming Potentiometers

FEATURES

- Single Turn/ Cermet/ Industrial/ Sealed.
- 7 Terminal Styles.

Electrical Characteristics	
Standard Resistance Range	10Ω - 2MΩ
Resistance Tolerance	±10% ; ±20% for 10 ohm
Absolute Minimum Resistance	≤10Ω (100Ω≤R≤1KΩ) ≤1%R(R>1K Ω)
Contact Resistance Variation	CRV≤3% or 5Ω (whichever is larger)
Insulation Resistance	R1≥1GΩ(500Vac)
Withstand Voltage	220VDC
Effective Travel	270°± 10°

Environmental Characteristics	
Power Rating (315volts max)	0.5W@70°C, 0W@125°C
Temperature Range	-55°C ~ +125°C
Temperature Coefficient	±200ppm/°C (±100ppm/°C on request)
Temperature Variation	-55°C, 30min, +125°C 30min, 5 cycles ΔR≤5%R, Δ(Uab/Uac)≤5%
Vibration	10 - 500Hz, 0.75mm, 6h ΔR≤5%R, Δ(Uab/Uac)≤7.5%R
Collision	390m/s ² , 4000cycles, ΔR≤5%R
Electrical Endurance at 70°C	0.5W@70°C 1000h, ΔR≤10%R CRV≤4% or 5Ω (whichever is larger)
Rotational Life	200 cycles ΔTR≤10%R, CRV≤3% or 5Ω (whichever is larger)

Physical Characteristics	
Starting Torque	≤35mN·m
Marking	Resistance Tolerance (When no identification, it is of ± 10%) Resistance Code, Model
Standard Packaging	50pcs, per tube

Common Dimensions Top Adjust

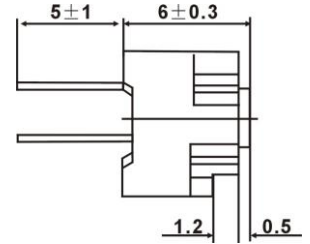
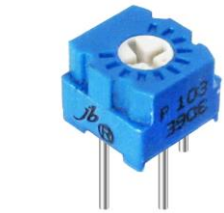
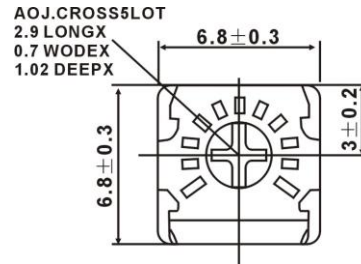

JBR-3323P

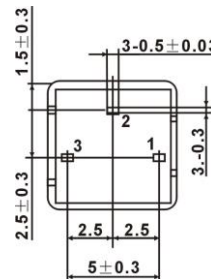

JBR-3323C

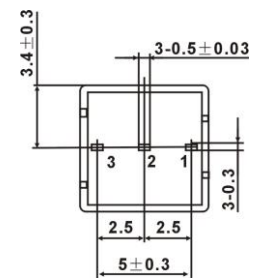

JBR-3323R

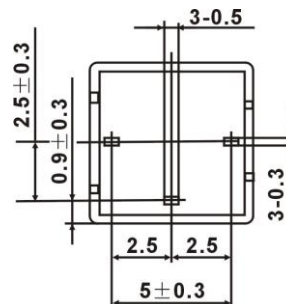

Please visit our website to get more update data, those data & specification are subject to change without notice.

JBR-3323 Trimming Potentiometers

Common Dimensions Side Adjust

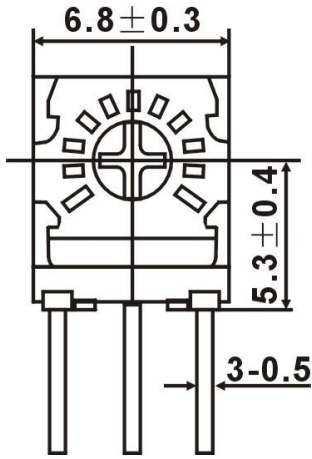

JBR-3323S

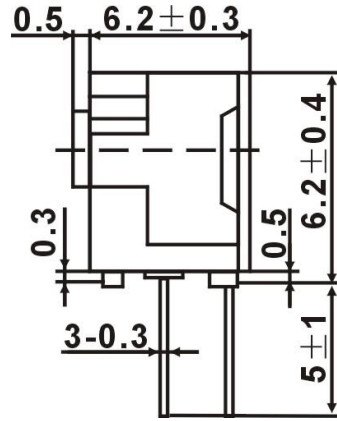

JBR-3323W

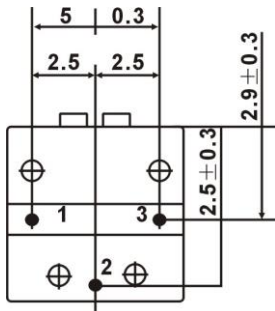

JBR-3323V

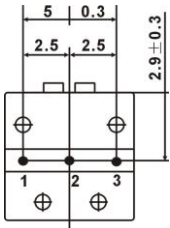

JBR-3323D Rear Adjust

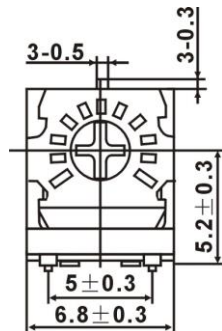
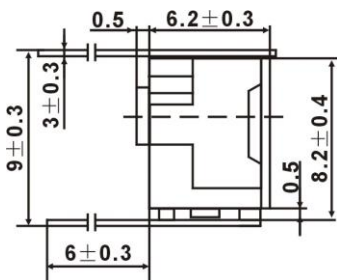

How to Order

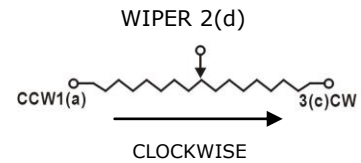
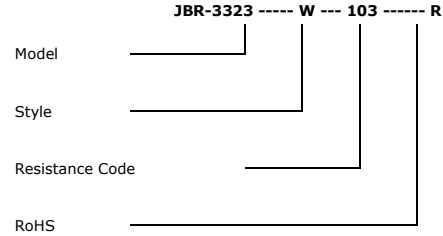

Tolerance is ± 0.25 if no identification

Resistance Table

Resistance (Ohms)	Resistance Code
100	101
150	151
200	201
250	251
300	301
470	471
500	501
680	681
1,000	102
1,500	152
2,000	202
2,200	222
2,500	252
3,000	302
4,700	472
5,000	502
6,800	682
10,000	103
15,000	153
20,000	203
22,000	223
25,000	253
30,000	303
33,000	333
47,000	473
50,000	503
68,000	683
100,000	104
150,000	154
200,000	204
220,000	224
250,000	254
300,000	304
330,000	334
470,000	474
500,000	504
680,000	684
1,000,000	105
2,000,000	205
2,200,000	225
5,000,000	505

Special resistance available

Please visit our website to get more update data, those data & specification are subject to change without notice.