

Metallized Polypropylene Film AC Capacitor Class-X1- JFT

FEATURES

- This specifications cover the requirements of jb Metallized Polypropylene
- Film AC Capacitor (Interference Suppressors Class-X1)

SPECIFICATIONS

Capacitor Class	"X1" stands for X1 class
Climatic Category	55/ 105/ 21
Operating Temperature Range	-55°C ~ +105°C (for which the capacitor can be operated continuously at rated voltage.
Rated Voltage	300V.AC, 440V.AC
Capacitance Range	0.0022 ~ 4.7 μ F
Capacitance Tolerance	\pm 10%
Insulation Resistance (I.R.)	\geq 15,000 MOhm ($C \leq 0.33 \mu$ F) \geq 5,000 MOhm ($C > 0.33 \mu$ F)
Dissipation Factor (DF)	0.001 (0.1%)max. at 1KHz

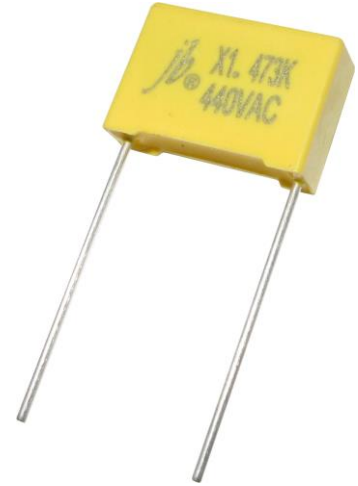

DRAWING

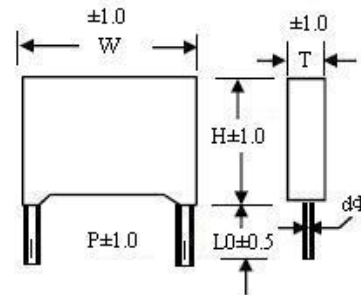
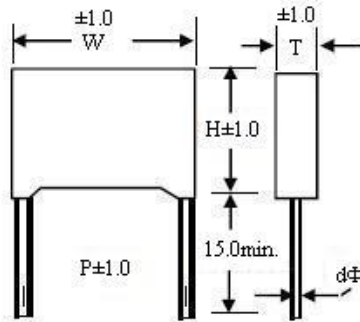

300V.AC STANDARD SIZE (mm)

Mfd	W \pm 1.0	H \pm 1.0	T \pm 1.0	P \pm 1.0
0.0022	13.0	11.0	5.0	10.0
0.0033	13.0	11.0	5.0	10.0
0.0047	13.0	11.0	5.0	10.0
0.0056	13.0	11.0	5.0	10.0
0.0068	13.0	11.0	5.0	10.0
0.0082	13.0	11.0	5.0	10.0
0.01	18.0	11.0	5.0	15.0
	13.0	11.0	5.0	10.0
0.012	18.0	12.0	6.0	15.0
	13.0	11.0	5.0	10.0
0.015	18.0	12.0	6.0	15.0
	13.0	11.0	5.0	10.0
0.018	18.0	12.0	6.0	15.0
	13.0	11.0	5.0	10.0
0.022	18.0	12.0	6.0	15.0
	13.0	12.0	6.0	10.0
0.027	18.0	12.0	6.0	15.0
	13.0	12.0	6.0	10.0
0.033	18.0	12.0	6.0	15.0
0.039	18.0	12.0	6.0	15.0
0.047	18.0	12.0	6.0	15.0
0.056	18.0	12.0	6.0	15.0
0.068	18.0	13.5	7.5	15.0
0.082	18.0	13.5	7.5	15.0
0.1	18.0	14.5	8.5	15.0
0.12	18.0	14.5	8.5	15.0
	26.5	16.5	7.0	22.5
0.15	18.0	16.0	10.0	15.0

Mfd	W \pm 1.0	H \pm 1.0	T \pm 1.0	P \pm 1.0
0.18	26.5	17.0	8.5	22.5
	18.0	18.0	10.0	15.0
0.2	26.5	17.0	8.5	22.5
0.22	26.5	17.0	8.5	22.5
0.27	26.5	19.0	10.0	22.5
0.33	32.0	18.0	9.0	27.5
	26.5	19.0	10.0	22.5
0.39	32.0	18.0	9.0	27.5
	26.5	19.0	10.0	22.5
0.47	32.0	20.0	11.0	27.5
	26.5	20.0	11.5	22.5
0.56	32.0	21.5	13.0	27.5
0.68	32.0	21.5	13.0	27.5
0.82	32.0	25.5	16.0	27.5
1.0	32.0	26.0	18.0	27.5
1.2	32.0	26.0	18.0	27.5
1.5	38.0	30.0	20.0	31.0
2.0	41.0	31.5	24.0	37.5
2.2	41.0	31.5	24.0	37.5
2.7	48.0	32.0	22.0	41.0
3.0	48.0	37.0	25.0	41.0
3.3	48.0	37.0	25.0	41.0
3.9	58.0	38.0	26.0	51.0
4.7	58.0	38.0	26.0	51.0
0.033	13.0	12.0	6.0	10.0

Please visit our website to get more update data, those data & specification are subject to change without notice.

Metallized Polypropylene Film AC Capacitor Class-X1- JFT

CHARACTERISTICS REFERENCE

Soldering Temperature VS Time

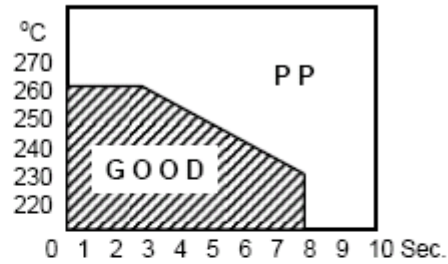
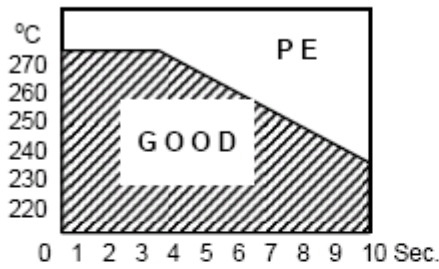

Frequency Characteristics

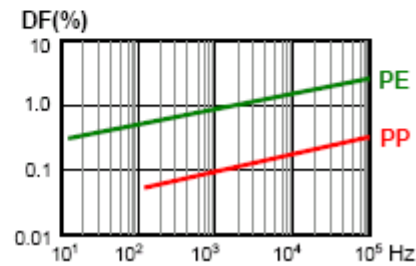
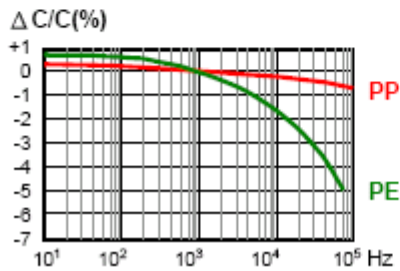

Temperature Characteristics

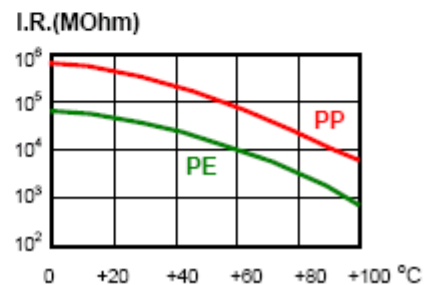
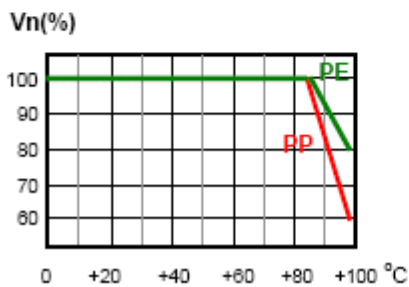
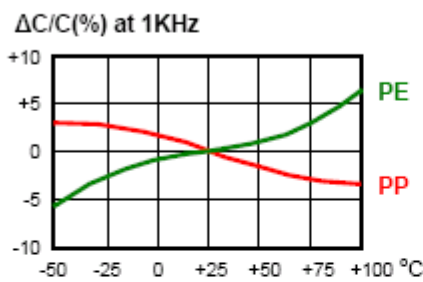

Please visit our website to get more update data, these data & specification are subject to change without notice.